

# PHAROS

## High-Power Femtosecond Lasers



### FEATURES

- 190 fs – 10 ps tunable pulse duration
- 2 mJ maximum pulse energy
- 20 W output power
- 1 kHz – 1 MHz tunable base repetition rate
- Pulse picker for pulse-on-demand operation
- Rugged, industrial grade mechanical design
- Automated harmonics generators (515 nm, 343 nm, 257 nm, 206 nm)

PHAROS is a single-unit integrated femtosecond laser system combining millijoule pulse energies and high average power. PHAROS features a mechanical and optical design optimized for industrial applications such as precise material processing. Market-leading compact size, integrated thermal stabilization system and sealed design allows PHAROS integration into machining workstations. The use of solid state laser diodes for pumping of Yb medium significantly reduces maintenance cost and provides long laser lifetime.

Most of the PHAROS output parameters can be easily set via PC tuning the laser for a particular application in seconds. Tunability of laser output parameters allows PHAROS system to cover applications normally requiring different classes of lasers. Tunable parameters include: pulse duration (190 fs – 10 ps),

repetition rate (single pulse to 1 MHz), pulse energy (up to 2 mJ) and average power (up to 20 W). Its deliverable power is abundant for most of material processing applications at high machining speeds. The built-in pulse picker allows convenient control of the laser output in pulse-on-demand mode. It comes along with an extensive external control interface dedicated for easy laser integration into larger setups and machining workstations. PHAROS compact and robust optomechanical design includes easy to replace modules with temperature stabilized and sealed housings ensuring stable laser operation across varying environments. PHAROS is equipped with an extensive software package, which ensures smooth hands-free operation.

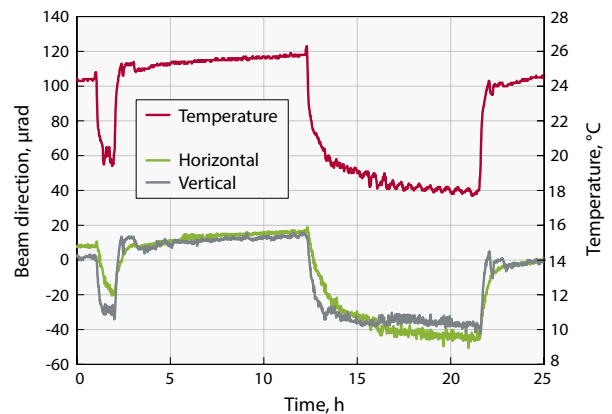
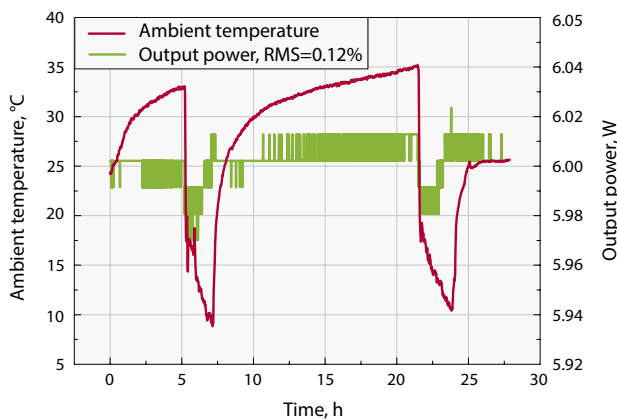

PHAROS output power with power lock on under unstable environment

SPECIFICATIONS

Model	PHAROS-6W	PHAROS-10W	PHAROS-15W	PHAROS-20W	PHAROS SP	PHAROS SP 1.5	PHAROS 2mJ
Max. average power	6 W	10 W	15 W	20 W	6 W		6 W
Pulse duration (assuming Gaussian pulse shape)	< 290 fs				< 190 fs		< 300 fs
Pulse duration range	290 fs – 10 ps				190 fs – 10 ps		300 fs – 10 ps
Max. pulse energy	> 0.2 mJ / > 0.4 mJ				> 1.0 mJ	> 1.5 mJ	> 2 mJ
Beam quality	TEM <sub>00</sub> ; M <sup>2</sup> < 1.2			TEM <sub>00</sub> ; M <sup>2</sup> < 1.3			
Base repetition rate	1 kHz – 1 MHz <sup>1)</sup>						
Pulse selection	Single-Shot, Pulse-on-Demand, any base repetition rate division						
Centre wavelength	1028 nm ± 5 nm						
Output pulse-to-pulse stability	< 0.5 % rms <sup>2)</sup>						
Power stability	< 0.5 % rms over 100 h						
Pre-pulse contrast	< 1 : 1000						
Post-pulse contrast	< 1 : 200						
Polarization	Linear, horizontal						
Beam pointing stability	< 20 μrad/°C						
Oscillator output	Optional, please see specifications of FLINT oscillators on page 14						

<sup>1)</sup> Some particular repetition rates are software denied due to system design.

<sup>2)</sup> Under stable environmental conditions.

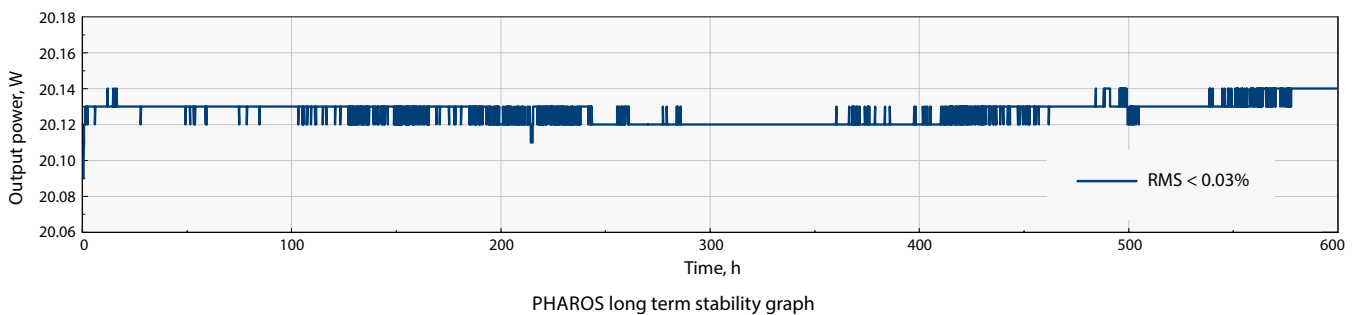
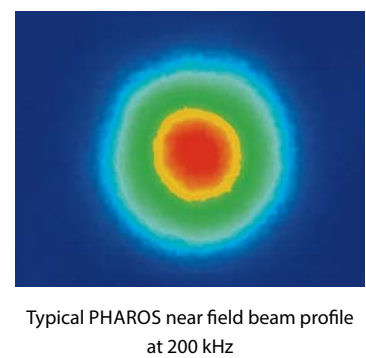
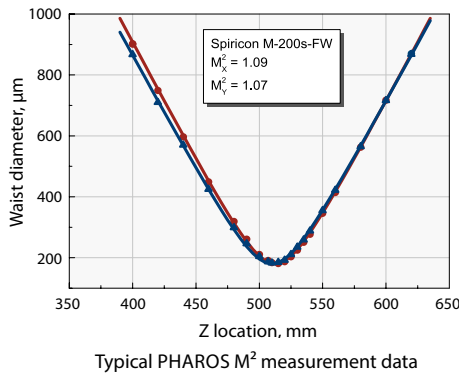
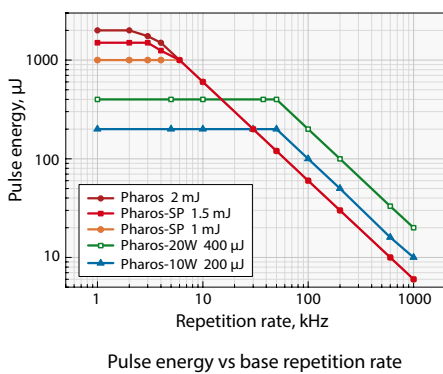
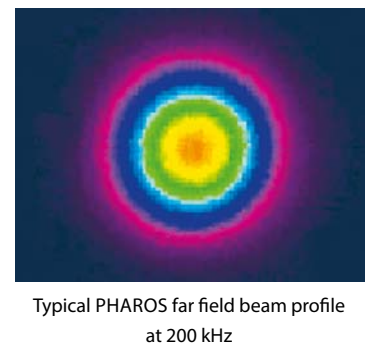
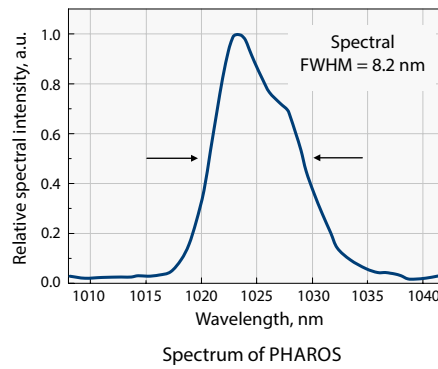
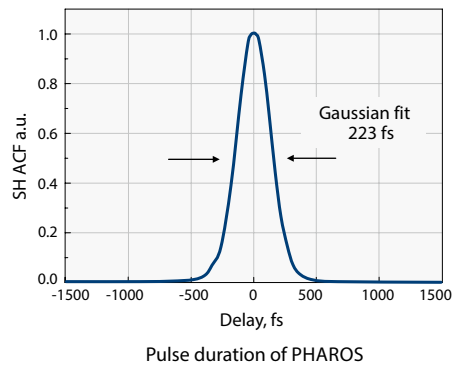

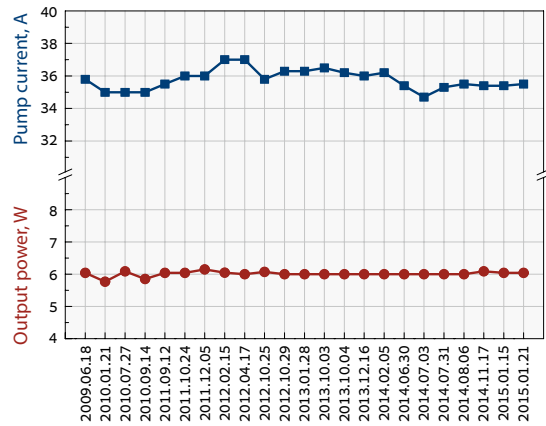
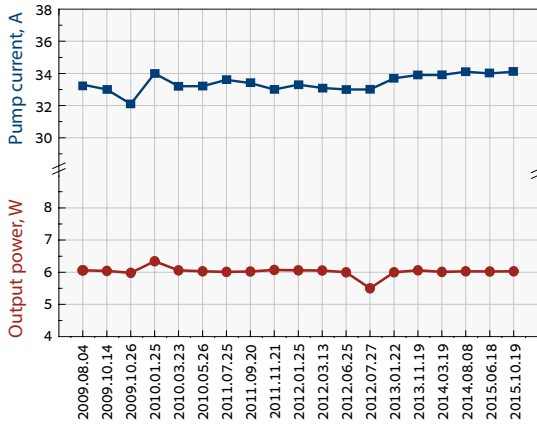

Output power of industrial PHAROS lasers operating 24/7 and current of pump diodes during the years

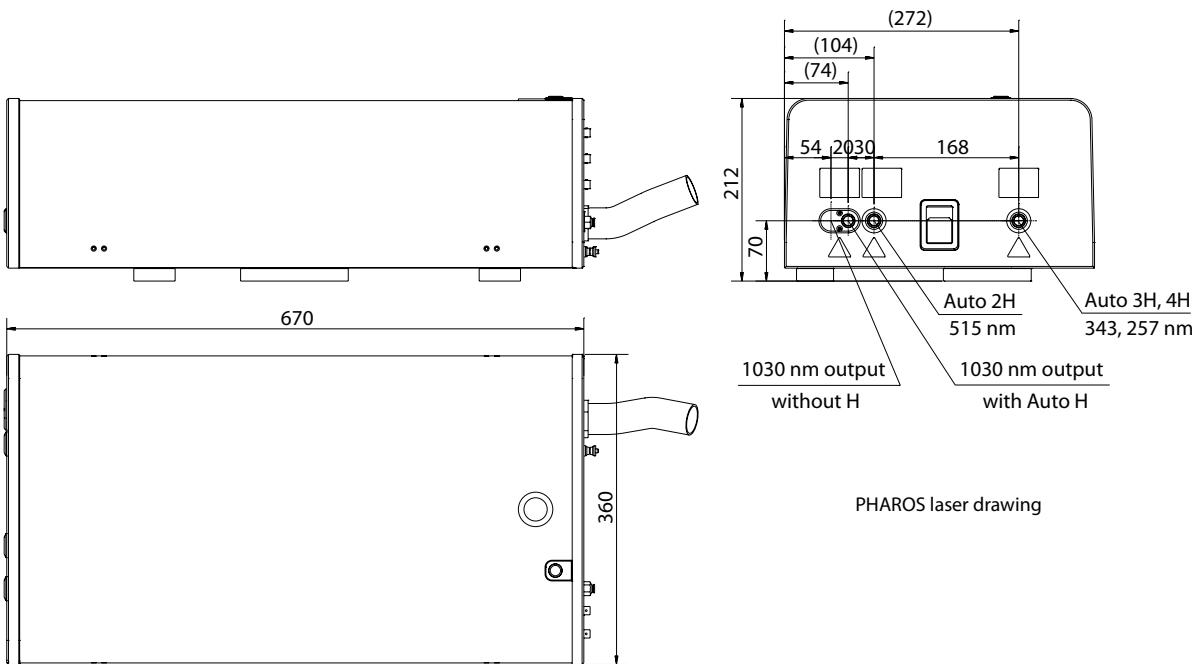

**PHYSICAL DIMENSIONS (mm)**

Laser head	670 L × 360 W × 212 H
Rack for power supply and chiller	640 L × 520 W × 660 H

**UTILITY REQUIREMENTS**

Electric	110 V AC, 50–60 Hz, 20 A or 220 V AC, 50–60 Hz, 10 A
Room temperature	15–30 °C (air conditioning recommended)
Relative humidity	20–80 % (non condensing)

# PHAROS

## Automated Harmonics Generators



### FEATURES

- 515 nm, 343 nm, 257 nm and 206 nm
- Output selection by software
- Mounts directly on laser head and integrated into the system
- Rugged, industrial grade mechanical design

PHAROS laser can be equipped with optional automated harmonics modules. Selection of fundamental (1030 nm), second (515 nm), third (343 nm), fourth (257 nm) or fifth (206 nm) harmonic output is available by software control. Harmonics generators are designed to be used in industrial applications where a single output wavelength is desired. Modules are mounted directly on the output of the laser and integrated into the system.

### SPECIFICATIONS

Model	2H	2H-3H	2H-4H	4H-5H
Output wavelength (automated selection)	1030 nm 515 nm	1030 nm 515 nm 343 nm	1030 nm 515 nm 257 nm	1030 nm 257 nm 206 nm
Input pulse energy	20 – 2000 $\mu$ J	50 – 1000 $\mu$ J	20 – 1000 $\mu$ J	200 – 1000 $\mu$ J
Pump pulse duration	190 – 300 fs			
Conversion efficiency	>50 % (2H)	>50 % (2H) >25 % (3H)	>50 % (2H) >10 % (4H) *	>10 % (4H) * >5 % (5H)
Pump laser beam quality ( $M^2$ )	<1.2 / <1.3 depends on a model			
Beam quality ( $M^2$ ) $\leq$ 400 $\mu$ J pump	515 nm: $M^2$ (pump) + 0.1	515 nm: $M^2$ (pump) + 0.1 343 nm: $M^2$ (pump) + 0.2	515 nm: $M^2$ (pump) + 0.1 257 nm: n/a	n/a
Beam quality ( $M^2$ ) $>$ 400 $\mu$ J pump	515 nm: $M^2$ (pump) + 0.2	515 nm: $M^2$ (pump) + 0.2 343 nm: $M^2$ (pump) + 0.3	515 nm: $M^2$ (pump) + 0.2 257 nm: n/a	n/a

\* Max 1 W output.

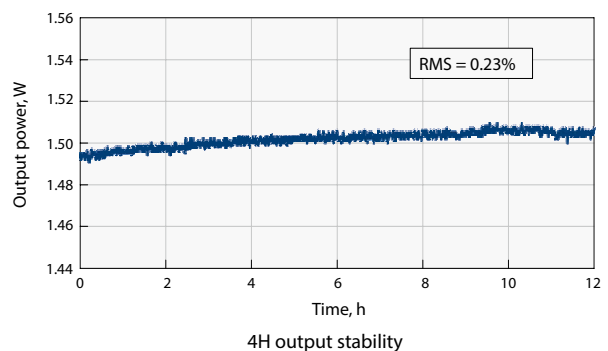
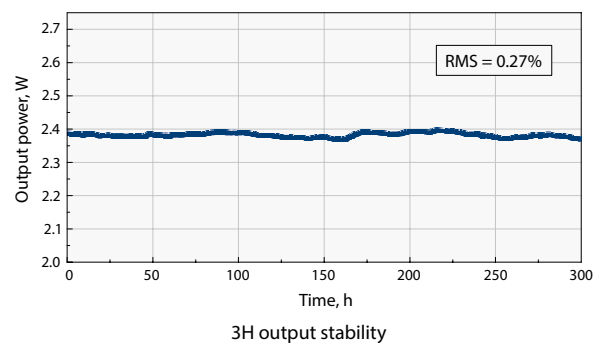
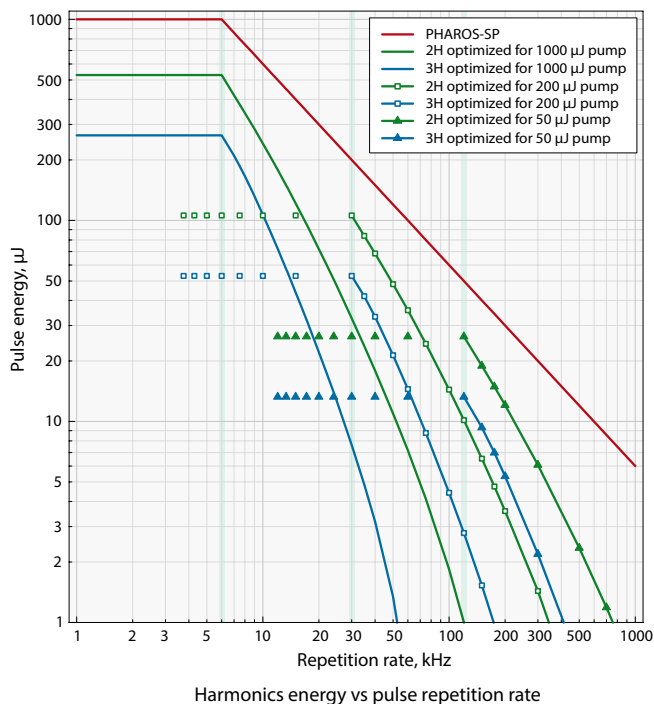

# PHAROS

## Industrial grade Optical Parametric Amplifier



### FEATURES

- Based on experience with ORPHEUS line
- Manually tunable wavelength
- Industrial grade design provides excellent long-term stability
- Very small footprint
- Bandwidth limited or short-pulse configurations available
- CEP option

I-OPA is an optical parametric amplifier of white-light continuum pumped by the PHAROS laser. This OPA is focused on generating long-term stable output with reliable and hands-off operation. Manually tunable output wavelength extends the application possibilities of a single laser source, instead of requiring multiple lasers based on different technologies.

In comparison to standard ORPHEUS line of devices, the I-OPA lacks only computer controlled wavelength selection. On the other hand, in-laser mounted design provides mechanical stability and eliminates the effects of air-turbulence, ensuring stable long-term performance and minimizing energy fluctuations.

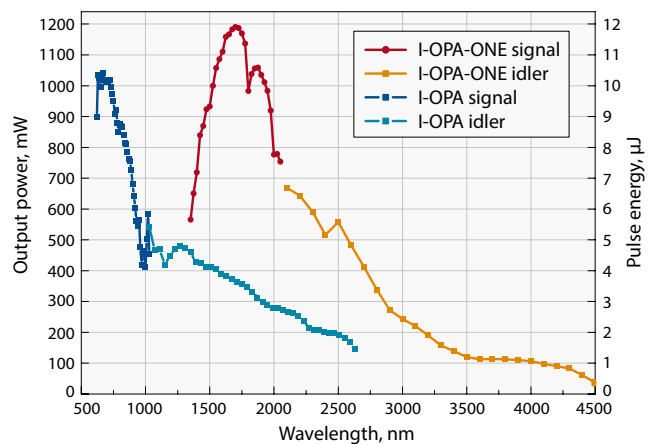

I-OPA module energy conversion curves.  
Pump: PHAROS-10W, 100 μJ, 100 kHz

### PHAROS i-OPA MODEL COMPARISON TABLE

Model	I-OPA	I-OPA-F	I-OPA-ONE	I-OPA-CEP
Based on OPA	ORPHEUS	ORPHEUS-F	ORPHEUS-ONE	–
Pump pulse energy	10 – 500 μJ	10 – 400 μJ	20 – 500 μJ	150 – 500 μJ
Pulse repetition rate	Up to 1 MHz			Up to 100 kHz
Tuning range, signal	630 – 1030 nm	650 – 900 nm	1350 – 2060 nm	–
Tuning range, idler	1030 – 2600 nm	1200 – 2500 nm	2060 – 4500 nm	1400 – 2500 nm
Conversion efficiency signal+idler combined	>12 %	>12 %	>15 %	>10 %
Pulse energy stability < 2% STD over 1 min.	650 – 950 nm 1150 – 2000 nm	650 – 850 nm 1350 – 2000 nm	1500 – 3500 nm	1400 – 2000 nm
Pulse bandwidth	100 – 150 cm <sup>-1</sup>	200 – 600 cm <sup>-1</sup>	80 – 200 cm <sup>-1</sup>	~150 cm <sup>-1</sup>
Pulse duration	150 – 250 fs	30 fs – 80 fs	200 – 300 fs	< 200 fs
Applications	Micro-machining Microscopy Spectroscopy	Nonlinear microscopy Ultrafast spectroscopy	Micro-machining Mid-IR generation	OPCPA front-end

<sup>1)</sup> Better stability can be specified for a specific wavelength (e.g. < 1% STD at 800 nm).

<sup>2)</sup> Output pulse duration depends on wavelength and pump laser pulse duration.

<sup>3)</sup> I-OPA-F outputs broad bandwidth pulses which are compressed externally.

COMPARISON WITH OTHER FEMTOSECOND AND PICOSECOND LASERS

Laser technology	Our solution	HG or HIRO	I-OPA-F	I-OPA-ONE
Pulse energy at 100 kHz, using PHAROS-10W laser				
Excimer laser (193 nm, 213 nm)	5H of PHAROS (205 nm)	5 $\mu\text{J}$	-	-
TH of Ti:Sa (266 nm)	4H of PHAROS (257 nm)	10 $\mu\text{J}$	-	-
TH of Nd:YAG (355 nm)	3H of PHAROS (343 nm)	25 $\mu\text{J}$	-	-
SH of Nd:YAG (532 nm)	2H of PHAROS (515 nm)	50 $\mu\text{J}$	35 $\mu\text{J}$	-
Ti:Sapphire (800 nm)	OPA output (750 – 850 nm)	-	10 $\mu\text{J}$	-
Nd:YAG (1064 nm)	PHAROS output (1030 nm)	100 $\mu\text{J}$		
Cr:Forsterite (1240 nm)	OPA output (1200 – 1300 nm)	-	5 $\mu\text{J}$	-
Erbium (1560 nm)	OPA output (1500 – 1600 nm)	-	3 $\mu\text{J}$	15 $\mu\text{J}$
Thulium / Holmium (1.95 – 2.15 $\mu\text{m}$ )	OPA output (1900 – 2200 nm)	-	2 $\mu\text{J}$	10 $\mu\text{J}$
Other sources (2.5 – 4.0 $\mu\text{m}$ )	OPA output	-	-	1 – 5 $\mu\text{J}$

Note that the pulse energy scales linearly in a broad range of pump parameters. For example, a PHAROS-20W laser at 50 kHz (400  $\mu\text{J}$  energy) will increase the output power twice, and the pulse energy – 4 times compared to the reference table above. The pulse duration at the output is <300 fs in all cases. The OPA output is not limited to these particular ranges of operation, it is continuously tunable as shown in energy conversion curves.

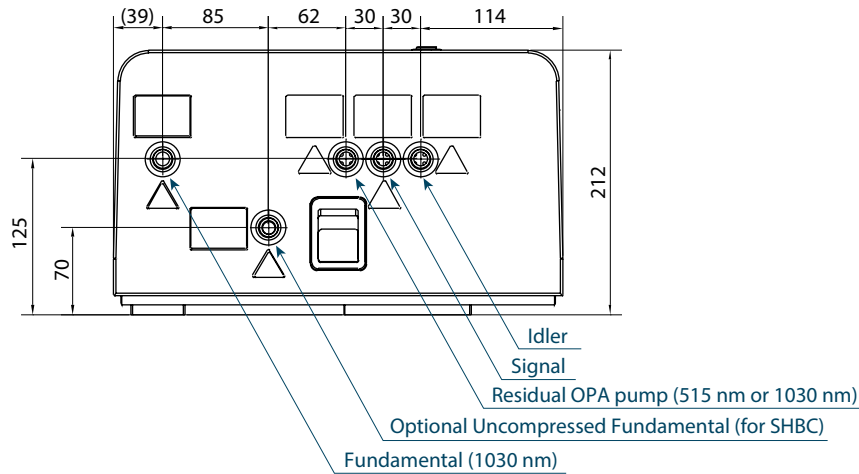

Pharos with I-OPA output ports

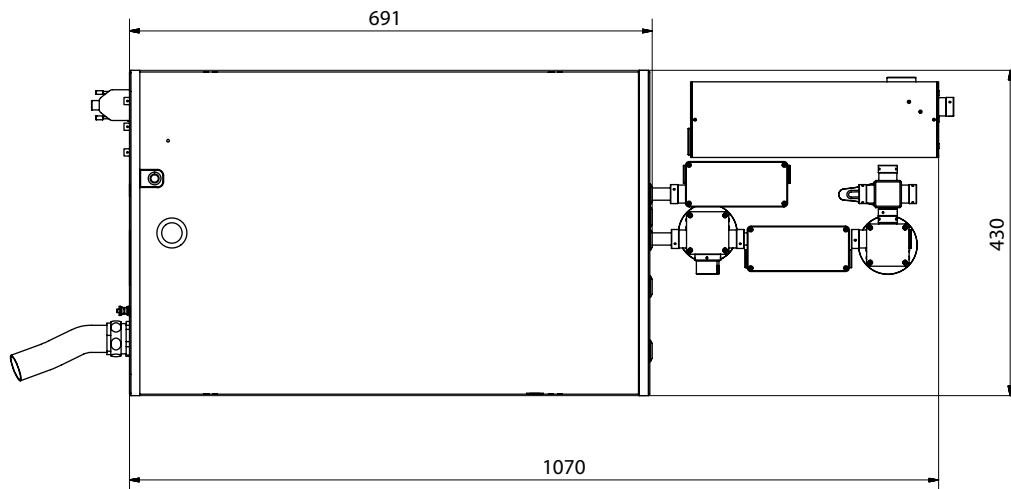

PHAROS with I-OPA-F and compressors for signal and idler